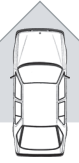

SOL / LEFT / ЛЕВАЯ

SAĞ / RIGHT / ПРАВАЯ

**104** 10/1972->06/1988

**305** 11/1977->09/1982

**304** 10/1969->10/1980

**As Metal Ref.**  
 Код As Metal

**Açıklama**  
 Description / Разъяснение

**Orijinal Kod**  
 Original Number / Оригинальный Код

As Metal Ref. Код As Metal	Açıklama Description / Разъяснение	Orijinal Kod Original Number / Оригинальный Код
10NS00	<b>Rotil</b> Ball Joint Шаровая опора	Alt 104 İÇİN Lower For 104 Нижняя Для 104
17PE1502	<b>Rotbaşı</b> Tie Rod End Наконечник рулевой тяги	M14x1,5 Sağ Diş (L=89mm) M14x1,5 RHT (L=89mm) M14x1,5 Правая резьба (L=89mm)

SOL / LEFT / ЛЕВАЯ

SAĞ / RIGHT / ПРАВАЯ

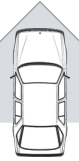
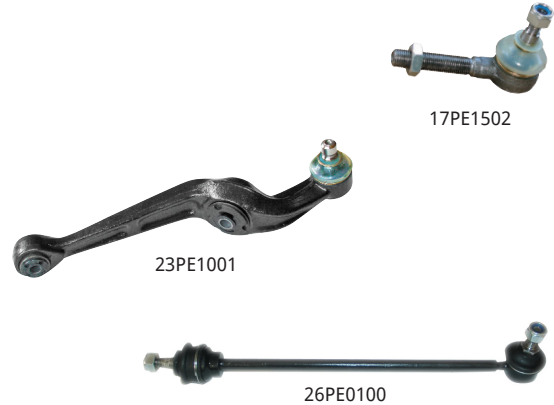
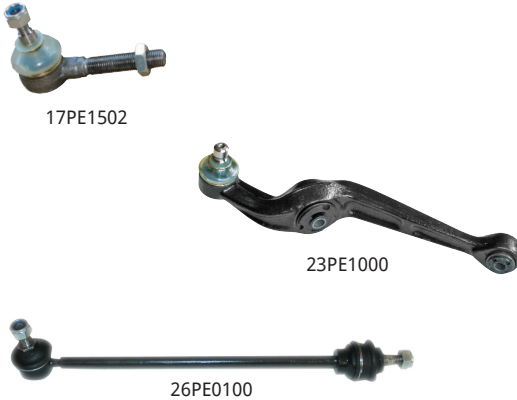
**205** 02/1983->09/1998

**As Metal Ref.**  
 Код As Metal

**Açıklama**  
 Description / Разъяснение

**Orijinal Kod**  
 Original Number / Оригинальный Код

As Metal Ref. Код As Metal	Açıklama Description / Разъяснение	Orijinal Kod Original Number / Оригинальный Код
17PE1502	<b>Rotbaşı</b> Tie Rod End Наконечник рулевой тяги	M14x1,5 Sağ Diş (L=89mm) M14x1,5 RHT (L=89mm) M14x1,5 Правая резьба (L=89mm)
23PE1000	<b>Rotilli Kol</b> Control Arm Рычаг	- - -
23PE1001	<b>Rotilli Kol</b> Control Arm Рычаг	- - -
26PE0100	<b>Viraj Rotu</b> Link Stabilizer Тяга стабилизатора	Ön Front Передняя

Asmetal products fit to mentioned trademarks and OE numbers in this catalogue.

SOL / LEFT / ЛЕВАЯ

SAĞ / RIGHT / ПРАВАЯ

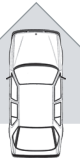

106

09/1991->



17PE0501



17PE0500

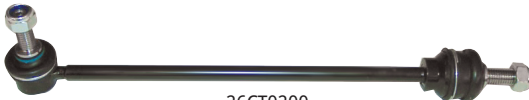

26CT0200

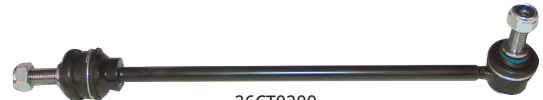

26CT0200



10PE2500



10PE2500



10CT2500



10CT2500

**As Metal Ref.**  
Код As Metal

**Açıklama**  
Description / Разъяснение

**Orijinal Kod**  
Original Number / Оригинальный Код

As Metal Ref. Код As Metal	Açıklama Description / Разъяснение	Orijinal Kod Original Number / Оригинальный Код
10PE2500	<b>Rotil</b> Ball Joint Шаровая опора	<b>Alt (Ø16mm)</b> Lower (Ø16mm) Нижняя (Ø16mm)
10CT2500	<b>Rotil</b> Ball Joint Шаровая опора	<b>Alt (Ø14mm)</b> Lower (Ø14mm) Нижняя (Ø14mm)
17PE0500	<b>Rotbaşı</b> Tie Rod End Наконечник рулевой тяги	<b>M14x1,5 Sağ Diş</b> M14x1,5 RHT M14x1,5 Правая Резьба
17PE0501	<b>Rotbaşı</b> Tie Rod End Наконечник рулевой тяги	<b>M14x1,5 Sağ Diş</b> M14x1,5 RHT M14x1,5 Правая Резьба
26CT0200	<b>Viraj Rotu</b> Link Stabilizer Тяга стабилизатора	<b>Ön</b> Front Передняя

Asmetal products fit to mentioned trademarks and OE numbers in this catalogue.

**SOL / LEFT / ЛЕВАЯ**
**SAĞ / RIGHT / ПРАВАЯ**
**206**

09/1998-&gt;

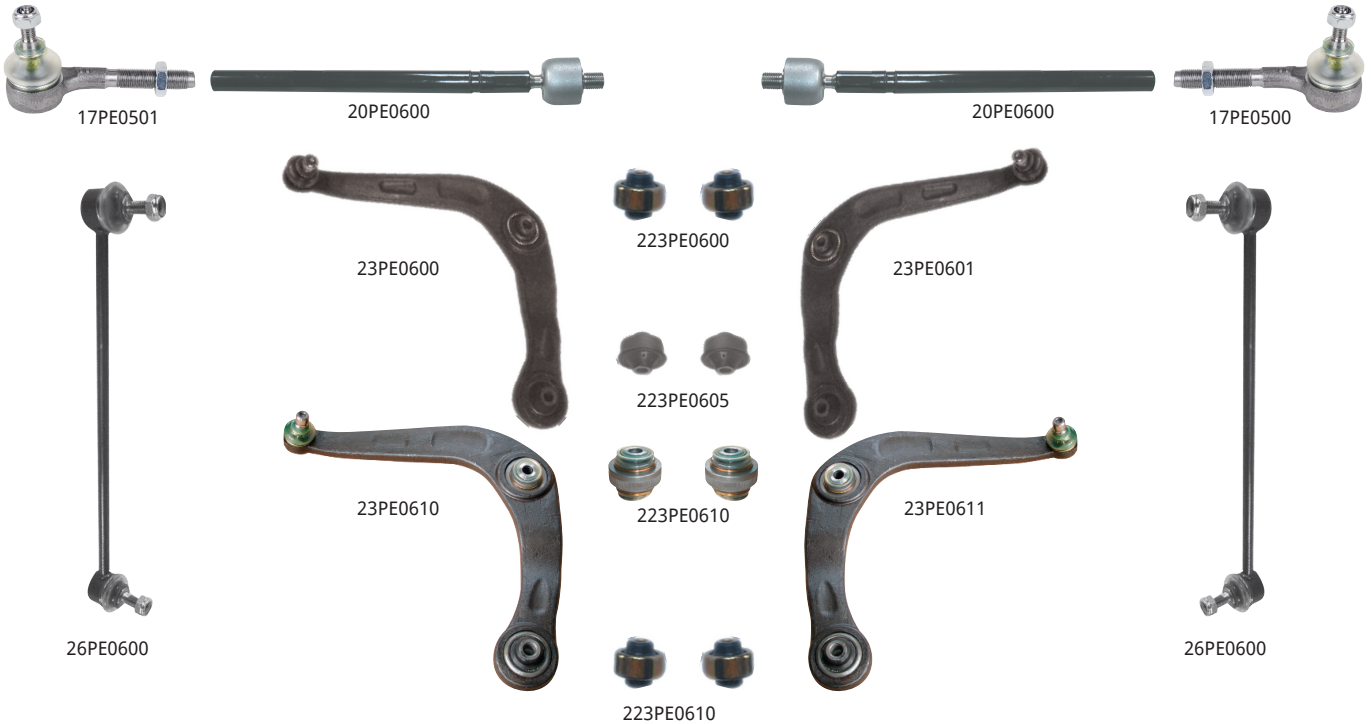
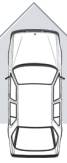
**As Metal Ref.**  
 Код As Metal

**Açıklama**  
 Description / Разъяснение

**Orijinal Kod**  
 Original Number / Оригинальный Код

As Metal Ref. Код As Metal	Açıklama Description / Разъяснение	Orijinal Kod Original Number / Оригинальный Код
17PE0500	<b>Rotbaşı</b> Tie Rod End Наконечник рулевой тяги	M14x1,5 Sağ Diş M14x1,5 RHT M14x1,5 Правая Резьба
17PE0501	<b>Rotbaşı</b> Tie Rod End Наконечник рулевой тяги	M14x1,5 Sağ Diş M14x1,5 RHT M14x1,5 Правая Резьба
20PE0600	<b>Rotmili</b> Axial Joint Тяга рулевая	M14x1,5 Sağ Diş M14x1,5 RHT M14x1,5 Правая Резьба
23PE0600	<b>Rotilli Kol</b> Control Arm Рычаг	- - -
23PE0601	<b>Rotilli Kol</b> Control Arm Рычаг	- - -
23PE0610	<b>Rotilli Kol</b> Control Arm Рычаг	(GTI için) (Only GTI) (Ha GTI)
23PE0611	<b>Rotilli Kol</b> Control Arm Рычаг	(GTI için) (Only GTI) (Ha GTI)
26PE0600	<b>Viraj Rotu</b> Link Stabilizer Тяга стабилизатора	Ön Front Передняя
223PE0600	<b>Rotilli Kol Burcu</b> Bushing Сайлентблок	Orta Center Центральный
223PE0605	<b>Rotilli Kol Burcu</b> Bushing Сайлентблок	Arka Rear Задняя
223PE0610	<b>Rotilli Kol Burcu</b> Bushing Сайлентблок	GTI için Only GTI Ha GTI

Asmetal products fit to mentioned trademarks and OE numbers in this catalogue.

SOL / LEFT / ЛЕВАЯ

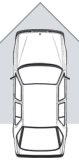

SAĞ / RIGHT / ПРАВАЯ

207

02/2006->



17PE0900

20PE0900



20PE0900

17PE0901



26PE0901



10CT0600



10CT0600



26PE0900

**As Metal Ref.**  
Код As Metal

**Açıklama**  
Description / Разъяснение

**Orijinal Kod**  
Original Number / Оригинальный Код

As Metal Ref. Код As Metal	Açıklama Description / Разъяснение	Orijinal Kod Original Number / Оригинальный Код
10CT0600	<b>Rotil</b> Ball Joint Шаровая опора	Alt Lower Нижняя 3640.56 / 3640.61 3640.62 / 3640.65 3640.59 / 3640.66
17PE0900	<b>Rotbaşı</b> Tie Rod End Наконечник рулевой тяги	<b>M16x1,5 Sağ Diş</b> M16x1,5 RHT M16x1,5 Правая Резьба 3817 67
17PE0901	<b>Rotbaşı</b> Tie Rod End Наконечник рулевой тяги	<b>M16x1,5 Sağ Diş</b> M16x1,5 RHT M16x1,5 Правая Резьба 3817 68
20PE0900	<b>Rotmili</b> Axial Joint Тяга рулевая	<b>M16x1,5 Sağ Diş</b> M16x1,5 RHT M16x1,5 Правая Резьба '3812 E8
26PE0900	<b>Viraj "Z" Rotu</b> Link Stabilizer Тяга стабилизатора	<b>Ön</b> Front Передняя 5087 55 5087 68
26PE0901	<b>Viraj "Z" Rotu</b> Link Stabilizer Тяга стабилизатора	<b>Ön</b> Front Передняя 5087 54 5087 69

Asmetal products fit to mentioned trademarks and OE numbers in this catalogue.

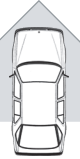
**SOL / LEFT / ЛЕВАЯ**
**SAĞ / RIGHT / ПРАВАЯ**

**305 10/1982->07/1990**

17PE0501



17PE0500



10PE1400



10PE1400

As Metal Ref. Код As Metal	Açıklama Description / Разъяснение	Orijinal Kod Original Number / Оригинальный Код
10PE1400	<b>Rotil</b> Ball Joint Шаровая опора	3640.21 / 95494204 96041652 / 3640 20 95 494 205 / 95 607 224
17PE0500	<b>Rotbaşı</b> Tie Rod End Наконечник рулевой тяги	M14x1,5 Sağ Diş M14x1,5 RHT M14x1,5 Правая Резьба
17PE0501	<b>Rotbaşı</b> Tie Rod End Наконечник рулевой тяги	M14x1,5 Sağ Diş M14x1,5 RHT M14x1,5 Правая Резьба

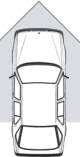
**SOL / LEFT / ЛЕВАЯ**
**SAĞ / RIGHT / ПРАВАЯ**

**305 XU 10/1982->12/1988**

17PE2000



17PE2001



10PE1400



10PE1400

As Metal Ref. Код As Metal	Açıklama Description / Разъяснение	Orijinal Kod Original Number / Оригинальный Код
10PE1400	<b>Rotil</b> Ball Joint Шаровая опора	3640.21 / 95494204 96041652 / 3640 20 95 494 205 / 95 607 224
17PE2000	<b>Rotbaşı</b> Tie Rod End Наконечник рулевой тяги	M14x1,5 Sağ Diş M14x1,5 RHT M14x1,5 Правая Резьба
17PE2001	<b>Rotbaşı</b> Tie Rod End Наконечник рулевой тяги	M14x1,5 Sağ Diş M14x1,5 RHT M14x1,5 Правая Резьба

Asmetal products fit to mentioned trademarks and OE numbers in this catalogue.

SOL / LEFT / ЛЕВАЯ

SAĞ / RIGHT / ПРАВАЯ

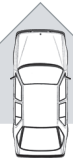

306

05/1993->



**As Metal Ref.**  
Код As Metal

**Açıklama**  
Description / Разъяснение

**Orijinal Kod**  
Original Number / Оригинальный Код

As Metal Ref. Код As Metal	Açıklama Description / Разъяснение	Orijinal Kod Original Number / Оригинальный Код
10PE1000	<b>Rotil</b> Ball Joint Шаровая опора <b>Alt, Hidrolik Direksiyon (Ø16mm) Şasi No : -&gt; O 07969</b> Lower, Power Steering (Ø16mm) Chassis Nr: -> O 07969 Нижняя, Для Гидравлического Руля (Ø16mm) Шасси Но: -> O 07969	3640.30 3640.37
10PE1001	<b>Rotil</b> Ball Joint Шаровая опора <b>Alt, Mekanik Direksiyon (Ø16mm) Şasi No : -&gt; O 07969</b> Lower, Manual Steering (Ø16mm) Chassis Nr: -> O 07969 Нижняя, Для Механического Руля (Ø16mm) Шасси Но: -> O 07969	3640.31 3640.44
10PE1002	<b>Rotil</b> Ball Joint Шаровая опора <b>Alt, Mekanik Direksiyon (Ø18mm) Şasi No : O 07970-&gt;</b> Lower, Manual Steering (Ø18mm) Chassis Nr: O 07970-> Нижняя, Для Механического Руля (Ø18mm) Шасси Но: O 07970->	3640.48
17PE1502	<b>Rotbaşı</b> Tie Rod End Наконечник рулевой тяги <b>M14x1,5 Sağ Diş (L=89mm)</b> M14x1,5 RHT (L=89mm) M14x1,5 Правая резьба (L=89mm)	3817.10 / 3817.18 / 3817.50 / 94 03 817 389 94 71 000 965 / 94 71 003 465 / 95 493 208 95 590 802
20PE1000	<b>Rotmili</b> Axial Joint Тяга рулевая <b>M14x1,5 Sağ Diş</b> M14x1,5 RHT M14x1,5 Правая Резьба	3812.92
26PE1000	<b>Viraj "Z" Rotu</b> Link Stabilizer Тяга стабилизатора <b>Ön, Plastik</b> Front, Plastic Передняя, Пластмассовая	5015.48 / 5084.38 / 5087.31 / 5087.34 / 5087.38 5087.39 / 5087.42 / 5087.46 / 5087.48 / 5087.61 5184 8645 / 5189 8527 / 9615 2213
26PE0500	<b>Viraj "Z" Rotu</b> Link Stabilizer Тяга стабилизатора <b>Ön</b> Front Передняя	->04/2002 5087 61 / 5087 39 5087 46 / 96 152 213
26CT0300	<b>Viraj "Z" Rotu</b> Link Stabilizer Тяга стабилизатора <b>Ön, Çelik</b> Front, Steel Передняя, Сталь	5015.48 / 5084.38 / 5087.31 / 5087.38 / 5087.34 5087.39 / 5087.42 / 5087.46 / 5087.48 / 5087.61 518 486 45 / 518 985 27 / 961 522 13
30PE1000	<b>Salıncak</b> Wishbone Рычаг	- 3521.55 3521.68 3521.A1
30PE1001	<b>Salıncak</b> Wishbone Рычаг	- 3520.98 3520.83 3521.F1
30PE1005	<b>Salıncak</b> Wishbone Рычаг <b>Alt</b> Lower Нижняя	'3521 E3
30PE1006	<b>Salıncak</b> Wishbone Рычаг <b>Alt</b> Lower Нижняя	3520.F3 3520.84 3520.99
30PE1010	<b>Salıncak</b> Wishbone Рычаг	- 3521 A1 / 3521 56 3521 69 / 3521 A2
30PE1011	<b>Salıncak</b> Wishbone Рычаг	- 3520 F1 3520 84
38CT0208	<b>Dış Burç</b> Outer Bushing Внешний Сайлентблок <b>M8</b> M8 M8	3523.75 3523.59 3523.62
38CT0210	<b>Dış Burç</b> Outer Bushing Внешний Сайлентблок <b>M10</b> M10 M10	3523.75 3523.59 3523.62

Asmetal products fit to mentioned trademarks and OE numbers in this catalogue.

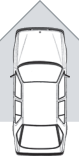
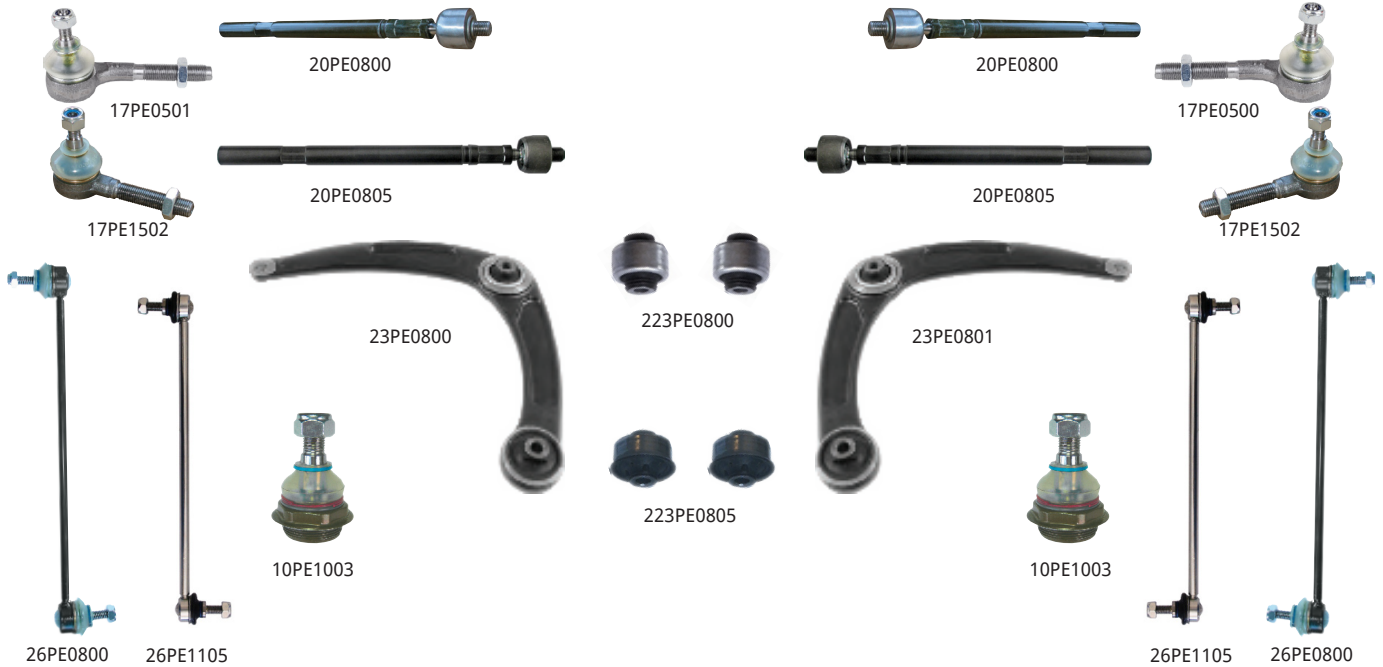
**SOL / LEFT / ЛЕВАЯ**
**SAĞ / RIGHT / ПРАВАЯ**

**307**
**08/2000->**

**As Metal Ref.**  
 Код As Metal

**Açıklama**  
 Description / Разъяснение

**Orijinal Kod**  
 Original Number / Оригинальный Код

As Metal Ref. Код As Metal	Açıklama Description / Разъяснение	Orijinal Kod Original Number / Оригинальный Код
10PE1003	<b>Rotil</b> Ball Joint Шаровая опора	3640.53 / 3640.60 3640.68 / 3640.70 3640.73
17PE0500	<b>Rotbaşı</b> Tie Rod End Наконечник рулевой тяги	M14x1,5 Sağ Diş M14x1,5 RHT M14x1,5 Правая Резьба
17PE0501	<b>Rotbaşı</b> Tie Rod End Наконечник рулевой тяги	M14x1,5 Sağ Diş M14x1,5 RHT M14x1,5 Правая Резьба
17PE1502	<b>Rotbaşı</b> Tie Rod End Наконечник рулевой тяги	M14x1,5 Sağ Diş (L=89mm) M14x1,5 RHT M14x1,5 Правая Резьба
20PE0800	<b>Rotmili</b> Axial Joint Тяга рулевая	M14x1,5 Sağ Diş M14x1,5 RHT M14x1,5 Правая Резьба
20PE0805	<b>Rotmili</b> Axial Joint Тяга рулевая	M14x1,5 Sağ Diş M14x1,5 RHT M14x1,5 Правая резьба
23PE0800	<b>Rotilli Kol</b> Control Arm Рычаг	- - -
23PE0801	<b>Rotilli Kol</b> Control Arm Рычаг	- - -
26PE0800	<b>Viraj "Z" Rotu</b> Link Stabilizer Тяга стабилизатора	Ön Front Передняя
26PE1105	<b>Viraj "Z" Rotu</b> Link Stabilizer Тяга стабилизатора	Ön Front Передняя
223PE0800	<b>Rotilli Kol Burcu</b> Control Arm Bushing Сайлентблок Рычага	Orta Center Центральный
223PE0805	<b>Rotilli Kol Burcu</b> Control Arm Bushing Сайлентблок Рычага	Arka Rear Задняя

Asmetal products fit to mentioned trademarks and OE numbers in this catalogue.



SOL / LEFT / ЛЕВАЯ

SAĞ / RIGHT / ПРАВАЯ

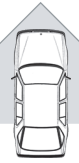

**309** 10/1985->12/1993



17PE1502



17PE1502



26PE0100



26PE0100

**As Metal Ref.**  
Код As Metal

**Açıklama**  
Description / Разъяснение

**Orijinal Kod**  
Original Number / Оригинальный Код

As Metal Ref. Код As Metal	Açıklama Description / Разъяснение	Orijinal Kod Original Number / Оригинальный Код
17PE1502	<b>Rotbaşı</b> Tie Rod End Наконечник рулевой тяги <b>M14x1,5 Sağ Diş (L=89mm)</b> M14x1,5 RHT (L=89mm) M14x1,5 Правая резьба (L=89mm)	3817.10 / 3817.18 / 3817.50 / 94 03 817 389 / 94 71 000 965 / 94 71 003 465 95 493 208 / 95 590 802
26PE0100	<b>Viraj Rotu</b> Link Stabilizer Тяга стабилизатора <b>Ön</b> Front Передняя	5087.23 5087.32 96 103 814

SOL / LEFT / ЛЕВАЯ

SAĞ / RIGHT / ПРАВАЯ

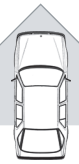

**405** 07/1987->10/1996



17PE2000

20PE90



20PE90

17PE2001



10PE1400



10PE2000



10PE2000



10PE1400

**As Metal Ref.**  
Код As Metal

**Açıklama**  
Description / Разъяснение

**Orijinal Kod**  
Original Number / Оригинальный Код

As Metal Ref. Код As Metal	Açıklama Description / Разъяснение	Orijinal Kod Original Number / Оригинальный Код
10PE1400	<b>Rotil</b> Ball Joint Шаровая опора <b>Alt Şasi : -&gt; 91358279</b> Lower Chassis : -> 91358279 Нижняя Шасси : -> 91358279	3640.21 / 95494204 96041652 / 3640 20 95 494 205 / 95 607 224
10PE2000	<b>Rotil</b> Ball Joint Шаровая опора <b>Alt Şasi : 91358280 -&gt;</b> Lower Chassis : 91358280 -> Нижняя Шасси : 91358280 ->	3640.28 / 3640.34 95 028 039 / 3640 71 96 233 739
17PE2000	<b>Rotbaşı</b> Tie Rod End Наконечник рулевой тяги <b>M14x1,5 Sağ Diş</b> M14x1,5 RHT M14x1,5 Правая Резьба	3817.21 / 3817.26 3817.48
17PE2001	<b>Rotbaşı</b> Tie Rod End Наконечник рулевой тяги <b>M14x1,5 Sağ Diş</b> M14x1,5 RHT M14x1,5 Правая Резьба	3817.22 / 3817.27 3817.49
20PE90	<b>Rotmili</b> Axial Joint Тяга рулевая <b>M14x1,5 Sağ Diş</b> M14x1,5 RHT M14x1,5 Правая Резьба	3812 98

Asmetal products fit to mentioned trademarks and OE numbers in this catalogue.

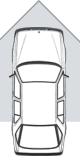

**SOL / LEFT / ЛЕВАЯ**
**SAĞ / RIGHT / ПРАВАЯ**

**406**

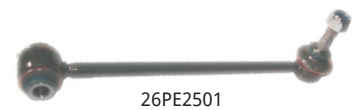
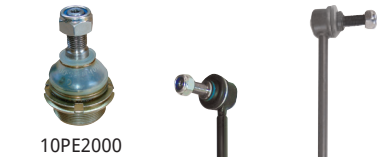
11/1995-&gt;12/2004

**As Metal Ref.**  
 Код As Metal

**Açıklama**  
 Description / Разъяснение

**Orijinal Kod**  
 Original Number / Оригинальный Код

10PE2000	<b>Rotil</b> Ball Joint Шаровая опора	<b>Alt</b> Lower Нижняя	3640.28 / 3640.34 95 028 039 / 3640 71 96 233 739
11PE2500	<b>Arka Dingil Tıkırtı Burcu</b> Silent Bushing Стояка Стабилизатора	<b>Alt</b> Lower Нижняя	3640.35
17PE2500	<b>Rotbaşı</b> Tie Rod End Наконечник рулевой тяги	<b>M16x1,5 Sağ Diş</b> M16x1,5 RHT M16x1,5 Правая Резьба	3817.40
17PE2501	<b>Rotbaşı</b> Tie Rod End Наконечник рулевой тяги	<b>M16x1,5 Sağ Diş</b> M16x1,5 RHT M16x1,5 Правая Резьба	3817.39
20PE2500	<b>Rotmili</b> Axial Joint Тяга рулевая	<b>M16x1,5 Sağ Diş</b> M16x1,5 RHT M16x1,5 Правая Резьба	3812 A9
26PE2500	<b>Viraj "Z" Rotu</b> Link Stabilizer Тяга стабилизатора	<b>Arka (Plastik)</b> Rear (Plastic) Задняя (Пластмассовая)	5178.38 96 152 300 80
26PE2501	<b>Viraj Rotu</b> Link Stabilizer Тяга стабилизатора	<b>Arka</b> Rear Задняя	5178.39 96 287 831 80
26PE2502	<b>Viraj "Z" Rotu</b> Link Stabilizer Тяга стабилизатора	<b>Ön Şasi No : O 07665 -&gt;</b> Front Chassis Nr : O 07665 -> <b>Передняя Шасси Но: O 07665 -&gt;</b>	5087.43 / 5087.48 5087.60 / 96 177 836
26CT0200	<b>Viraj Rotu</b> Link Stabilizer Тяга стабилизатора	<b>Ön, Şasi No : -&gt; O 07664</b> Front, Chassis Nr : -> O 07664 <b>Передняя, Шасси Но: -&gt; O 07664</b>	5087.40 9631 583 680

Asmetal products fit to mentioned trademarks and OE numbers in this catalogue.

SOL / LEFT / ЛЕВАЯ

SAĞ / RIGHT / ПРАВАЯ

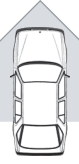

407

05/2004->



17PE4700

20PE4700



20PE4700

17PE4701



26PE4703



26PE4700



26PE4701



26PE4703



10PE4700



10PE4700

**As Metal Ref.**  
Код As Metal

**Açıklama**  
Description / Разъяснение

**Orijinal Kod**  
Original Number / Оригинальный Код

As Metal Ref. Код As Metal	Açıklama Description / Разъяснение	Orijinal Kod Original Number / Оригинальный Код
10PE4700	<b>Rotil</b> Ball Joint Шаровая опора	<b>Üst, Ön</b> Upper, Front Верхняя, Передняя
17PE4700	<b>Rotbaşı</b> Tie Rod End Наконечник рулевой тяги	<b>M14x1,5 Sağ Diş</b> M14x1,5 RHT M14x1,5 Правая Резьба
17PE4701	<b>Rotbaşı</b> Tie Rod End Наконечник рулевой тяги	<b>M14x1,5 Sağ Diş</b> M14x1,5 RHT M14x1,5 Правая Резьба
20PE4700	<b>Rotmili</b> Axial Joint Тяга рулевая	<b>M14x1,5 Sağ Diş</b> M14x1,5 RHT M14x1,5 Правая Резьба
26PE4700	<b>Viraj Rotu</b> Link Stabilizer Тяга стабилизатора	<b>Ön</b> Front Передняя
26PE4701	<b>Viraj Rotu</b> Link Stabilizer Тяга стабилизатора	<b>Ön</b> Front Передняя
26PE4703	<b>Viraj "Z" Rotu</b> Link Stabilizer Тяга стабилизатора	<b>Arka</b> Rear Задняя

Asmetal products fit to mentioned trademarks and OE numbers in this catalogue.

SOL / LEFT / ЛЕВАЯ

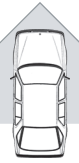

SAĞ / RIGHT / ПРАВАЯ

**605**

06/1989-&gt;09/1999



17PE0501



17PE0500



26CT0100



10PE2000



10PE2000



26CT0100



26PE2000



26PE2001

PEUGEOT

As Metal Ref. Код As Metal	Açıklama Description / Разъяснение	Orijinal Kod Original Number / Оригинальный Код
10PE2000	<b>Rotil</b> Ball Joint Шаровая опора	3640.28 / 3640.34 95 028 039 / 3640 71 / 96 233 739
17PE0500	<b>Rotbaşı</b> Tie Rod End Наконечник рулевой тяги	M14x1,5 Sağ Diş M14x1,5 RHT M14x1,5 Правая Резьба
17PE0501	<b>Rotbaşı</b> Tie Rod End Наконечник рулевой тяги	M14x1,5 Sağ Diş M14x1,5 RHT M14x1,5 Правая Резьба
26PE2000	<b>Viraj "Z" Rotu</b> Link Stabilizer Тяга стабилизатора	<b>Arka</b> Rear Задняя
26PE2001	<b>Viraj "Z" Rotu</b> Link Stabilizer Тяга стабилизатора	<b>Arka</b> Rear Задняя
26CT0100	<b>Viraj Rotu</b> Link Stabilizer Тяга стабилизатора	<b>Ön</b> Front Передняя

Asmetal products fit to mentioned trademarks and OE numbers in this catalogue.

SOL / LEFT / ЛЕВАЯ

SAĞ / RIGHT / ПРАВАЯ

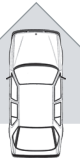

607

02/2000->



26PE2502



26PE2502



26PE2000



26PE2001



10PE2000



10PE2000

As Metal Ref. Код As Metal	Açıklama Description / Разъяснение		Orijinal Kod Original Number / Оригинальный Код
10PE2000	<b>Rotil</b> Ball Joint Шаровая опора	<b>Alt</b> Lower Нижняя	3640.28 / 3640.34 95 028 039 / 3640 71 / 96 233 739
26PE2000	<b>Viraj "Z" Rotu</b> Link Stabilizer Тяга стабилизатора	<b>Arka</b> Rear Задняя	5178.17 / 5178.21 5178.30 / 5178.43
26PE2001	<b>Viraj "Z" Rotu</b> Link Stabilizer Тяга стабилизатора	<b>Arka</b> Rear Задняя	5178.18 / 5178.22 5178.31 / 5178.44
26PE2502	<b>Viraj "Z" Rotu</b> Link Stabilizer Тяга стабилизатора	<b>Ön</b> Front Передняя	5087.43 / 5087.48 5087.60 / 96 177 836

Asmetal products fit to mentioned trademarks and OE numbers in this catalogue.

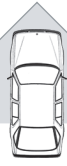
**SOL / LEFT / ЛЕВАЯ**

**SAĞ / RIGHT / ПРАВАЯ**
**504** 07/1968->12/1989

**505** 08/1979->12/1993

**604** 08/1977->07/1987

17PE1502



10PE1500



10PE1500



17PE1502

As Metal Ref. Код As Metal	Açıklama Description / Разъяснение	Orijinal Kod Original Number / Оригинальный Код
10PE1500	<b>Rotil</b> Ball Joint Шаровая опора  <b>Alt</b> Lower Нижняя	3640.15 / 3640.25 3640.27
17PE1502	<b>Rotbaşı</b> Tie Rod End Наконечник рулевой тяги  <b>M14x1,5 Sağ Diş (L=89mm)</b> M14x1,5 RHT (L=89mm) M14x1,5 Правая резьба (L=89mm)	3817.10 / 3817.18 / 3817.50 / 94 03 817 389 / 94 71 000 965 / 94 71 003 465 95 493 208 / 95 590 802

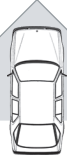
**SOL / LEFT / ЛЕВАЯ**

**SAĞ / RIGHT / ПРАВАЯ**
**806** 06/1994->08/2002

**Expert** 07/1995->

17FI5100



20FI5100



20FI5100



17FI5100



26FI5100



26FI5100

As Metal Ref. Код As Metal	Açıklama Description / Разъяснение	Orijinal Kod Original Number / Оригинальный Код
17FI5100	<b>Rotbaşı</b> Tie Rod End Наконечник рулевой тяги  <b>M14x1,5 Sağ Diş</b> M14x1,5 RHT M14x1,5 Правая Резьба	4059.09 / 13 06 003 080 94 04 059 580
20FI5100	<b>Rotmili</b> Axial Joint Тяга рулевая  <b>M14x1,5 Sağ Diş</b> M14x1,5 RHT M14x1,5 Правая Резьба	3812 A4 / 95 66 950 880 9 947 713
26FI5100	<b>Askı Rotu</b> Thrust Rod Тяга стабилизатора  <b>Ön</b> Front Передняя	1308 664 080 1317 425 080 5087.35

Asmetal products fit to mentioned trademarks and OE numbers in this catalogue.

SOL / LEFT / ЛЕВАЯ

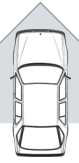

SAĞ / RIGHT / ПРАВАЯ

1007

04/2005->



17CT0600



20CT0600



20CT0600



17CT0601



26PE0600



26PE0600



10CT0600



10CT0600

**As Metal Ref.**  
Код As Metal

**Açıklama**  
Description / Разъяснение

**Orijinal Kod**  
Original Number / Оригинальный Код

As Metal Ref. Код As Metal	Açıklama Description / Разъяснение	Orijinal Kod Original Number / Оригинальный Код
10CT0600	<b>Rotil</b> Ball Joint Шаровая опора	Alt Lower Нижняя 3640.56 / 3640.59 3640.61 / 3640.62 3640.65 / 3640.66
17CT0600	<b>Rotbaşı</b> Tie Rod End Наконечник рулевой тяги	M14x1,5 Sağ Diş M14x1,5 RHT M14x1,5 Правая резьба 3817,55
17CT0601	<b>Rotbaşı</b> Tie Rod End Наконечник рулевой тяги	M14x1,5 Sağ Diş M14x1,5 RHT M14x1,5 Правая резьба 3817,56
20CT0600	<b>Rotmili</b> Axial Joint Тяга рулевая	M14x1,5 Sağ Diş M14x1,5 RHT M14x1,5 Правая резьба 3812.E1
26PE0600	<b>Viraj Rotu</b> Link Stabilizer Тяга стабилизатора	Ön Front Передняя 5087.45 / 5087.59 5087.66 / 5087.71 5087.74 / 96 288 787

Asmetal products fit to mentioned trademarks and OE numbers in this catalogue.

SOL / LEFT / ЛЕВАЯ

SAĞ / RIGHT / ПРАВАЯ

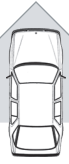

**Bipper**

02/2008->

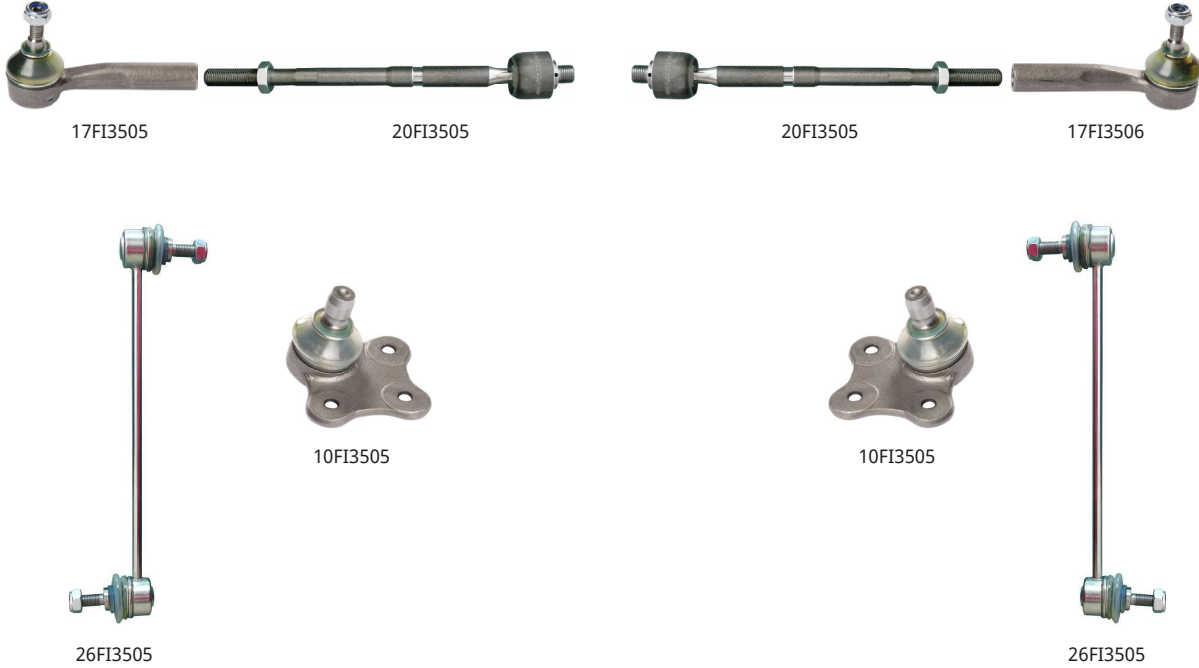

PEUGEOT

As Metal Ref. Код As Metal	Açıklama Description / Разъяснение	Orijinal Kod Original Number / Оригинальный Код
10FI3505	<b>Rotil</b> Ball Joint Шаровая опора	<b>Alt</b> Lower Нижняя 51 783 057 / 51 783 056 3520 W3 / 3521 S6 / 352 087 352 067 / 93 190 907 / 93 188 808
17FI3505	<b>Rotbaşı</b> Tie Rod End Наконечник рулевой тяги	<b>M14x1,5 Sağ Diş</b> M14x1,5 RHT M14x1,5 Правая Резьба 1609 457 / 1603 544 / 3817 86 773 64 568 / 773 63 829 931 96 541 / 931 89 023
17FI3506	<b>Rotbaşı</b> Tie Rod End Наконечник рулевой тяги	<b>M14x1,5 Sağ Diş</b> M14x1,5 RHT M14x1,5 Правая Резьба 1603 545 / 3817 87 773 64 569 / 773 63 830 931 89 024
20FI3505	<b>Rotmili</b> Axial Joint Тяга рулевая	<b>M14x1,5 Sağ Diş</b> M14x1,5 RHT M14x1,5 Правая Резьба ---
26FI3505	<b>Viraj "Z" Rotu</b> Link Stabilizer Тяга стабилизатора	<b>Ön</b> Front Передняя 508770 / 508765 / 508779 51704008 / 51815479 51815480

Asmetal products fit to mentioned trademarks and OE numbers in this catalogue.



SOL / LEFT / ЛЕВАЯ

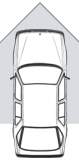

SAĞ / RIGHT / ПРАВАЯ

**Boxer** 03/1994-> ->04/2002



17FI3200

20FI3200



20FI3200

17FI3200



526PE0500



526PE0500



10FI3002



10FI3003



10FI3003



10FI3002

**As Metal Ref.**  
Код As Metal

**Açıklama**  
Description / Разъяснение

**Orijinal Kod**  
Original Number / Оригинальный Код

As Metal Ref. Код As Metal	Açıklama Description / Разъяснение	Orijinal Kod Original Number / Оригинальный Код
10FI3002	<b>Rotil</b> Ball Joint Шаровая опора	<b>Alt (1 - 1.4 Ton)</b> Lower (1 - 1.4 Ton) Нижняя (1 - 1.4 Тон)
10FI3003	<b>Rotil</b> Ball Joint Шаровая опора	<b>Alt (1 - 1.8 Ton)</b> Lower (1 - 1.8 Ton) Нижняя (1 - 1.8 Тон)
17FI3200	<b>Rotbaşı</b> Tie Rod End Наконечник рулевой тяги	<b>M16x1,5 Sağ Diş</b> M16x1,5 RHT M16x1,5 Правая Резьба
20FI3200	<b>Rotmili</b> Axial Joint Тяга рулевая	<b>M16x1,5 Sağ Diş</b> M16x1,5 RHT M16x1,5 Правая Резьба
526PE0500	<b>Viraj Tandır Kolu</b> Bend Arm Стойка стабилизатора	<b>Ön</b> Front Передняя

Asmetal products fit to mentioned trademarks and OE numbers in this catalogue.

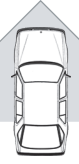
**SOL / LEFT / ЛЕВАЯ**
**SAĞ / RIGHT / ПРАВАЯ**

**Boxer**
**04/2002->**

17FI3200



17FI3200



17FI3205



17FI3205



526PE0500



526PE0500



10FI3004



10FI3004



10FI3005



10FI3005

**PEUGEOT**

As Metal Ref. Код As Metal	Açıklama Description / Разъяснение	Orijinal Kod Original Number / Оригинальный Код
10FI3004	<b>Rotil</b> Ball Joint Шаровая опора <b>Alt (1 - 1.4 Ton)</b> Lower (1 - 1.4 Ton) Нижняя (1 - 1.4 Тон)	1331 640 080 3640.55
10FI3005	<b>Rotil</b> Ball Joint Шаровая опора <b>Alt (1 - 1.8 Ton)</b> Lower (1 - 1.8 Ton) Нижняя (1 - 1.8 Тон)	1331 641 080 3640.54
17FI3200	<b>Rotbaşı</b> Tie Rod End Наконечник рулевой тяги <b>M16x1,5 Sağ Diş</b> M16x1,5 RHT M16x1,5 Правая Резьба	130 671 6080 4018.A3 / 4018.H4
17FI3205	<b>Rotbaşı</b> Tie Rod End Наконечник рулевой тяги <b>M16x1,5 Sağ Diş</b> M16x1,5 RHT M16x1,5 Правая Резьба	4018.E0 77 362 278
526PE0500	<b>Viraj Tandır Kolu</b> Bend Arm Стойка стабилизатора <b>Ön</b> Front Передняя	0181 602-K 5087 37 / 13 00 716 080

Asmetal products fit to mentioned trademarks and OE numbers in this catalogue.

SOL / LEFT / ЛЕВАЯ

SAĞ / RIGHT / ПРАВАЯ

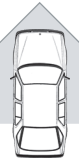

**Boxer**

04/2006->

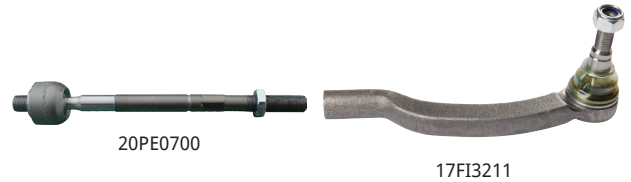
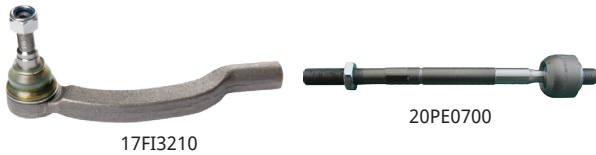

17FI3210

20PE070

20PE070

17FI3211



526PE1000



526PE1000



10FI3210



10FI3210

**As Metal Ref.**  
Код As Metal

**Açıklama**  
Description / Разъяснение

**Orijinal Kod**  
Original Number / Оригинальный Код

As Metal Ref. Код As Metal	Açıklama Description / Разъяснение		Orijinal Kod Original Number / Оригинальный Код
10FI3210	<b>Rotil</b> Ball Joint Шаровая опора	<b>Alt</b> Lower Нижняя	3640.67 / 507 05629 3640 76 / 935 01 837
17FI3210	<b>Rotbaşı</b> Tie Rod End Наконечник рулевой тяги	<b>M16x1,5 Sağ Diş</b> M16x1,5 RHT M16x1,5 Правая Резьба	3817.69 3817.77 773 642 53
17FI3211	<b>Rotbaşı</b> Tie Rod End Наконечник рулевой тяги	<b>M16x1,5 Sağ Diş</b> M16x1,5 RHT M16x1,5 Правая Резьба	3817.70 773 64009
20PE070	<b>Rotmili</b> Axial Joint Тяга рулевая	<b>M16x1,5 Sağ Diş</b> M16x1,5 RHT M16x1,5 Правая Резьба	-
526PE1000	<b>Viraj Tandır Kolu</b> Bend Arm Стойка стабилизатора	<b>Ön</b> Front Передняя	0001350658080 1300 720 080 / 1357 572 080

Asmetal products fit to mentioned trademarks and OE numbers in this catalogue.

SOL / LEFT / ЛЕВАЯ

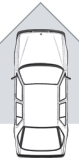

SAĞ / RIGHT / ПРАВАЯ

**J5** 01/1981->03/1994



17FI3000

20AR0100



20AR0100

17FI3000



10FI3000



10FI3000



10FI3001



10FI3001

PEUGEOT

As Metal Ref. Код As Metal	Açıklama Description / Разъяснение		Orijinal Kod Original Number / Оригинальный Код
10FI3000	<b>Rotil</b> Ball Joint Шаровая опора	<b>Alt -&gt;09/1990</b> Lower ->09/1990 Нижняя ->09/1990	3640.18 438 8159
10FI3001	<b>Rotil</b> Ball Joint Шаровая опора	<b>Alt 09/1981-&gt;</b> Lower 09/1981-> Нижняя 09/1981->	3640.26 756 7284 541 2669
17FI3000	<b>Rotbaşı</b> Tie Rod End Наконечник рулевой тяги	<b>M16x1,5 Sağ Diş</b> M16x1,5 RHT M16x1,5 Правая Резьба	4336779 / 3817.11 9750 079 980
20AR0100	<b>Rotmili</b> Axial Joint Тяга рулевая	<b>M16x1,5 Sağ Diş</b> M16x1,5 RHT M16x1,5 Правая Резьба	9750390080 / 9750001180 3812.27 / 979 000 2680 0242.12 / 1201.E1

Asmetal products fit to mentioned trademarks and OE numbers in this catalogue.

SOL / LEFT / ЛЕВАЯ

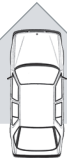

SAĞ / RIGHT / ПРАВАЯ

**J7** 08/1968->03/1980



17PE1030



17PE1050



22PE1070



10PE1015



10PE1015



10PE1055



10PE1055

**As Metal Ref.**

Kod As Metal

**Açıklama**

Description / Разъяснение

**Orijinal Kod**

Original Number / Оригинальный Код

As Metal Ref. Kod As Metal	Açıklama Description / Разъяснение	Orijinal Kod Original Number / Оригинальный Код
10PE1015	<b>Rotil</b> Ball Joint Шаровая опора	Üst Upper Верхняя 3608.25 / 3608.28 9380 4061 / 9380 2242 9380 7545
10PE1055	<b>Rotil</b> Ball Joint Шаровая опора	Alt Lower Нижняя 3622.15
17PE1030	<b>Rotbaşı</b> Tie Rod End Наконечник рулевой тяги	M20x1,5 Sağ Diş M20x1,5 RHT M20x1,5 Правая Резьба 3874.31
17PE1050	<b>Rotbaşı</b> Tie Rod End Наконечник рулевой тяги	M20x1,5 Sol Diş M20x1,5 LHT M20x1,5 Левая резьба 3874.30
22PE1070	<b>Orta Rot</b> Center Rod Центральная Тяга	Sabit Fixed Неподвижная 3813.30

Asmetal products fit to mentioned trademarks and OE numbers in this catalogue.

SOL / LEFT / ЛЕВАЯ

SAĞ / RIGHT / ПРАВАЯ

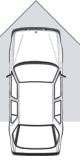

J9

03/1980->



17PE1030



17PE1050



17PE3500



22PE1070



17PE3501



21PE3500



21PE3500



10PE1015



10PE1055



10PE1055



10PE1015

**As Metal Ref.**  
Код As Metal

**Açıklama**  
Description / Разъяснение

**Orijinal Kod**  
Original Number / Оригинальный Код

As Metal Ref. Код As Metal	Açıklama Description / Разъяснение	Orijinal Kod Original Number / Оригинальный Код
10PE1015	<b>Rotil</b> Ball Joint Шаровая опора	<b>Üst</b> Upper Верхняя ->06/1987 3608.25 / 3608.28 9380 4061 / 9380 2242 9380 7545
10PE1055	<b>Rotil</b> Ball Joint Шаровая опора	<b>Alt</b> Lower Нижняя 3622.15
17PE1030	<b>Rotbaşı</b> Tie Rod End Наконечник рулевой тяги	<b>M20x1,5 Sağ Diş</b> M20x1,5 RHT M20x1,5 Правая Резьба 3874.31
17PE1050	<b>Rotbaşı</b> Tie Rod End Наконечник рулевой тяги	<b>M20x1,5 Sol Diş</b> M20x1,5 LHT M20x1,5 Левая резьба 3874.30
17PE3500	<b>Rotbaşı</b> Tie Rod End Наконечник рулевой тяги	<b>M8x1,25 Sol Diş (Kapı Üst Mek.Rotu için)</b> M8x1,25 LHT (For Door Upper Mecanizm) M8x1,25 Левая резьба (Для верхнего дверного механизма) PT 5039
17PE3501	<b>Rotbaşı</b> Tie Rod End Наконечник рулевой тяги	<b>M8x1,25 Sağ Diş (Kapı Üst Mek.Rotu için)</b> M8x1,25 RHT (For Door Upper Mecanizm) M8x1,25 Правая резьба (Для верхнего дверного механизма) PT 5040
21PE3500	<b>Ara Rot</b> Tie Rod Тяга в сборе	<b>Ayarlı (Kapı Üst Mek. için)</b> Adjustable (For Door Upper Mecanizm) Регулируется (Для верхнего дверного механизма) PT 5149
22PE1070	<b>Orta Rot</b> Center Rod Центральная Тяга	<b>Sabit</b> Fixed Неподвижная 3813.30

Asmetal products fit to mentioned trademarks and OE numbers in this catalogue.

SOL / LEFT / ЛЕВАЯ

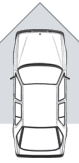

SAĞ / RIGHT / ПРАВАЯ

**Partner** 06/1996->

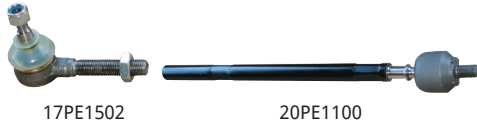

17PE1502

20PE1100



20PE1100

17PE1502



26CT0300



10PE1100



30CT1016



30CT1015



26CT0300



10PE1100



26PE0500



10CT0200



30CT1021



30CT1020



10CT0200



26PE0500



30PE1031



30PE1030



26PE1000



10CT0100



10CT0100



26PE1000



38CT0208



38CT0210



SOL / LEFT / ЛЕВАЯ

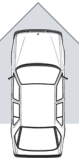

SAĞ / RIGHT / ПРАВАЯ

**Partner** 06/1996->

As Metal Ref. Код As Metal	Açıklama Description / Разъяснение	Orijinal Kod Original Number / Оригинальный Код
10PE1100	<b>Rotil</b> Ball Joint Шаровая опора <b>Alt (Ø18mm) Şasi No: O 07973 -&gt;</b> Lower (Ø18mm) Chassis Nr: O 07973 -> Нижняя (Ø18mm) Шасси Но: O 07973 ->	3640.50 3640.51
10CT0100	<b>Rotil</b> Ball Joint Шаровая опора <b>Alt, Mekanik Direksiyon (Ø16mm) Şasi No: O 07969 -&gt;</b> Lower, Manual Steering (Ø16mm) Chassis Nr: O 07969 -> Нижняя, Для Механического Руля (Ø16mm) Шасси Но: -> O 07969	3640.39 / 3640.43 960 87 507
10CT0200	<b>Rotil</b> Ball Joint Шаровая опора <b>Alt, Hidrolik Direksiyon (Ø16mm) Şasi No: -&gt; O 07972</b> Lower, Power Steering (Ø16mm) Chassis Nr: -> O 07972 Нижняя, Для Гидравлического Руля (Ø16mm) Шасси Но:-> O 07972	3640.38 / 3640.42 960 25 445 / 961 03 696
17PE1502	<b>Rotbaşı</b> Tie Rod End Наконечник рулевой тяги <b>M14x1,5 Sağ Diş (L=89mm)</b> M14x1,5 RHT (L=89mm) M14x1,5 Правая резьба (L=89mm)	3817.10 / 3817.18 / 3817.50 / 9403817389 9471000965 / 9471003465 954 93 208 / 95 590 802
20PE1100	<b>Rotmili</b> Axial Joint Тяга рулевая <b>M14x1,5 Sağ Diş</b> M14x1,5 RHT M14x1,5 Правая Резьба	3812.C0 3812.C6 96 048 214
26PE0500	<b>Viraj "Z" Rotu</b> Link Stabilizer Тяга стабилизатора <b>Ön</b> Front Передняя	5087 61 / 5087 39 5087 46 / 96 152 213
26PE1000	<b>Viraj "Z" Rotu</b> Link Stabilizer Тяга стабилизатора <b>Ön (Plastik)</b> Front (Plastic) Передняя (Пластик)	5015.48 / 5084.38 / 5087.31 / 5087.34 5087.38 / 5087.39 / 5087.42 / 5087.46 5087.48 5087.61 / 5184 8645 / 5189 8527 9615 2213
26CT0300	<b>Viraj "Z" Rotu</b> Link Stabilizer Тяга стабилизатора <b>Ön</b> Front Передняя	5087.34 / 5087.39 / 5087.46 / 961 52 213 5015.48 / 5084.38 / 5087.31 / 5087.38 / 5087.42 5087.48 / 5087.61 / 518 486 45 / 518 985 27
30CT1015	<b>Salıncak</b> Wishbone Рычаг	3521.A6 / 3521.C6 956 588 83 / 956 855 13
30CT1016	<b>Salıncak</b> Wishbone Рычаг	3520 A1 / 3520 H5 / 3520 A2 / 3520 A6 3520 F5 / 3520 F6 / 95 658 882 95 658 884 / 95 668 510 / 95 668 512
30CT1020	<b>Salıncak</b> Wishbone Рычаг	3521 A5 3521 E3 3521 E5
30CT1021	<b>Salıncak</b> Wishbone Рычаг	3520 A2 / 3520 F5 3520 F7 / 3520 G3 3520 G5
30PE1030	<b>Salıncak</b> Wishbone Рычаг	3521 E5 / 3521 E6 95 658 884 / 95 668 510 3521 E8
30PE1031	<b>Salıncak</b> Wishbone Рычаг	3520 H5 / 95 658 885 / 95 668 511 3520 H6 / 3520 H8
38CT0208	<b>Diş Burç</b> Outer Bushing Внешний Сайлентблок <b>M8</b> M8 M8	3523.75 3523.59 3523.62
38CT0210	<b>Diş Burç</b> Outer Bushing Внешний Сайлентблок <b>M10</b> M10 M10	3523.75 3523.59 3523.62

Asmetal products fit to mentioned trademarks and OE numbers in this catalogue.

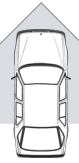
**SOL / LEFT / ЛЕВАЯ**

**SAĞ / RIGHT / ПРАВАЯ**
**308** 09/2007->

**Partner** 04/2008->

**Partner Tepee** 04/2008->

17PE1105

20PE1105



20PE1105

17PE1106



26PE1105



26PE0800



23PE0800



23PE0801



26PE1105

26PE0800



10PE1003



10PE1003

**As Metal Ref.**  
 Код As Metal

**Açıklama**  
 Description / Разъяснение

**Orijinal Kod**  
 Original Number / Оригинальный Код

As Metal Ref. Код As Metal	Açıklama Description / Разъяснение	Orijinal Kod Original Number / Оригинальный Код
10PE1003	<b>Rotil</b> Ball Joint Шаровая опора	<b>Alt</b> Lower Нижняя 3640.53 / 3640.60 3640.68 / 3640.70 3640.73
17PE1105	<b>Rotbaşı</b> Tie Rod End Наконечник рулевой тяги	<b>M14x1,5 Sağ Diş</b> M14x1,5 RHT M14x1,5 Правая Резьба 3817.89 3817.76
17PE1106	<b>Rotbaşı</b> Tie Rod End Наконечник рулевой тяги	<b>M14x1,5 Sağ Diş</b> M14x1,5 RHT M14x1,5 Правая Резьба 3817.88 3817.75
20PE1105	<b>Rotmili</b> Axial Joint Тяга рулевая	<b>M14x1,5 Sağ Diş</b> M14x1,5 RHT M14x1,5 Правая Резьба <b>(Sağ-Sol)</b> (RHT-LHT) (Правая-Левая) 3812 F4 3812 F2
26PE0800	<b>Viraj "Z" Rotu</b> Link Stabilizer Тяга стабилизатора	<b>Ön</b> Front Передняя 5087.50 / 5087.57 / 5087.62 / 5087.64 5087.77 / 5087.78 / 9634 7856
26PE1105	<b>Viraj "Z" Rotu</b> Link Stabilizer Тяга стабилизатора	<b>Ön</b> Front Передняя 5087 50 / 5087 57 5087 62 / 5087 64 5087 77
23PE0800	<b>Rotilli Kol</b> Control Arm Рычаг	<b>308 HARIÇ</b> Except 308 Кроме 308 3520 S2 3520 P3 3520 K8
23PE0801	<b>Rotilli Kol</b> Control Arm Рычаг	<b>308 HARIÇ</b> Except 308 Кроме 308 3521 K3 3521 P3 3521 G8

Asmetal products fit to mentioned trademarks and OE numbers in this catalogue.

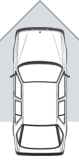
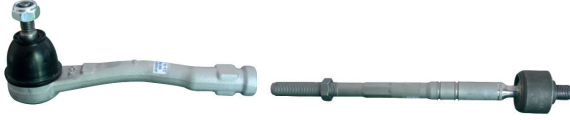
**SOL / LEFT / ЛЕВАЯ**
**SAĞ / RIGHT / ПРАВАЯ**

**3008**
**06/2009->**
**5008**
**06/2009->**

17PE1105

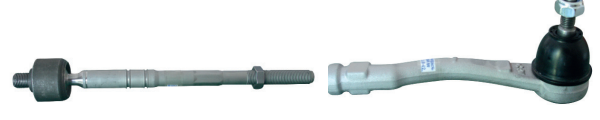
20PE1105



20PE1105

17PE1106



26PE0800



26PE1105



10PE1003



26PE0800



26PE1105



10PE1003

**PEUGEOT**
**As Metal Ref.**  
 Код As Metal

**Açıklama**  
 Description / Разъяснение

**Orijinal Kod**  
 Original Number / Оригинальный Код

As Metal Ref. Код As Metal	Açıklama Description / Разъяснение	Orijinal Kod Original Number / Оригинальный Код
10PE1003	<b>Rotil</b> Ball Joint Шаровая опора	Alt Lower Нижняя 3640.53 / 3640.60 3640.68 / 3640.70 3640.73
17PE1105	<b>Rotbaşı</b> Tie Rod End Наконечник рулевой тяги	M14x1,5 Sağ Diş M14x1,5 RHT M14x1,5 Правая Резьба 3817.89 3817.76
17PE1106	<b>Rotbaşı</b> Tie Rod End Наконечник рулевой тяги	M14x1,5 Sağ Diş M14x1,5 RHT M14x1,5 Правая Резьба 3817.88 3817.75
20PE1105	<b>Rotmili</b> Axial Joint Тяга рулевая	M14x1,5 Sağ Diş M14x1,5 RHT M14x1,5 Правая Резьба 3812 F4 3812 F2
26PE0800	<b>Viraj "Z" Rotu</b> Link Stabilizer Тяга стабилизатора	Ön Front Передняя 5087.50 / 5087.57 / 5087.62 / 5087.64 5087.77 / 5087.78 / 9634 7856
26PE1105	<b>Viraj "Z" Rotu</b> Link Stabilizer Тяга стабилизатора	Ön Front Передняя 5087 50 / 5087 57 5087 62 / 5087 64 5087 77

Asmetal products fit to mentioned trademarks and OE numbers in this catalogue.

SOL / LEFT / ЛЕВАЯ

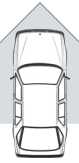

SAĞ / RIGHT / ПРАВАЯ

**Rotmilleri (Axial Joints)**



20PE01



20PE01



20PE02



20PE02



20PE03



20PE03



20PE04



20PE04



20PE05



20PE05

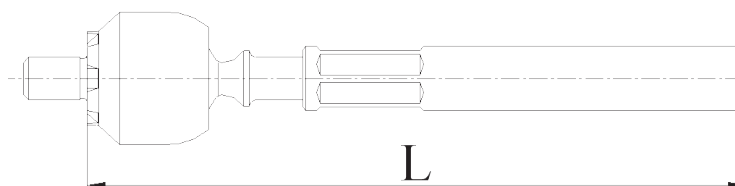

**As Metal Ref.**  
Код As Metal

**Açıklama**  
Description / Разъяснение

**Orijinal Kod**  
Original Number / Оригинальный Код

As Metal Ref. Код As Metal	Açıklama Description / Разъяснение	Orijinal Kod Original Number / Оригинальный Код
20PE01	<b>Rotmili</b> Axial Joint Тяга рулевая <b>M14x1,5 Sağ Diş (L=198mm)</b> M14x1,5 RHT (L=198mm) M14x1,5 Правая Резьба (L=198mm)	-
20PE02	<b>Rotmili</b> Axial Joint Тяга рулевая <b>M14x1,5 Sağ Diş (L=273mm)</b> M14x1,5 RHT (L=273mm) M14x1,5 Правая Резьба (L=273mm)	-
20PE03	<b>Rotmili</b> Axial Joint Тяга рулевая <b>M14x1,5 Sağ Diş (L=318mm)</b> M14x1,5 RHT (L=318mm) M14x1,5 Правая Резьба (L=318mm)	-
20PE04	<b>Rotmili</b> Axial Joint Тяга рулевая <b>M14x1,5 Sağ Diş (L=190mm)</b> M14x1,5 RHT (L=190mm) M14x1,5 Правая Резьба (L=190mm)	-
20PE05	<b>Rotmili</b> Axial Joint Тяга рулевая <b>M14x1,5 Sağ Diş (L=315mm)</b> M14x1,5 RHT (L=315mm) M14x1,5 Правая Резьба (L=315mm)	-

Asmetal products fit to mentioned trademarks and OE numbers in this catalogue.