

SOL / LEFT / ЛЕВАЯ

SAG / RIGHT / ПРАВАЯ

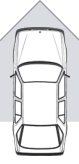

Accent 10/1994->01/2000

Coupe 08/1996->04/2002



As Metal Ref.
Код As Metal

Açıklama
Description / Разъяснение

Orijinal Kod
Original Number / Оригинальный Код

| As Metal Ref. Код As Metal | Açıklama Description / Разъяснение | Orijinal Kod Original Number / Оригинальный Код |
|-------------------------------|--|--|
| 10HY0500 | Rotil Ball Joint Шаровая опора | Alt Lower Нижняя 54503 22A00 / 54503 22000 / 54530 2F000 / 54503 25A00 54530 25A00 / 54530 25000 / 54530 31600 / 54520 31600 54503 31600 / 54503 38A00 / 54530-0U000 / AW311699 / MB241883 MB303374 / MB303375 |
| 17HY0500 | Rotbaşı Tie Rod End Наконечник рулевой тяги | M14x1,5 Sağ Diş M14x1,5 RHT M14x1,5 Правая Резьба 56820-22000 / 56820-25000 56820-28500 / 56820-37000 56820-37010 |
| 20HY10 | Rotmili Axial Joint Тяга рулевая | M14x1,5 Sağ Diş M14x1,5 RHT M14x1,5 Правая резьба Accent İçin For Accent Для Accent 57730-43010 / 57730-43000 / 57729 4A000 56540 28020 / 57730 24000 / 57730 28500 57730 33100 / 57755 22000 / 56542 4B000 57730 4A000 / 57730 4B000 |
| 2615HY0500 | Askı Rotu Tamir Takımı Thrust Rod Repair Kit Ремонтный набор тяги стабилизатора | (Coupe Hariç) (Except Coupe) (Кроме Coupe) 54825-22000 |
| 26HY0510 | Viraj "Z" Rotu Link Stabilizer Тяга стабилизатора | Ön Front Передняя (Coupe Hariç) (Except Coupe) (Кроме Coupe) 54830-25010 54830-17010 4056A015 / MR 316368 |
| 26HY0511 | Viraj "Z" Rotu Link Stabilizer Тяга стабилизатора | Ön Front Передняя (Coupe Hariç) (Except Coupe) (Кроме Coupe) 54830-25020 54830-17020 MR 316369 |
| 26HY0600 | Viraj Rotu Link Stabilizer Тяга стабилизатора | Ön Front Передняя Coupe İçin For Coupe Для Coupe 54830-29000 54830-29500 |
| 26HY0605 | Viraj Rotu Link Stabilizer Тяга стабилизатора | Arka Rear Задняя Coupe İçin ->08/2009 For Coupe ->08/2009 Для Coupe ->08/2009 55530-29500 / 55530-29000 55530-17000 / 55530-17010 55530-29300 |

Asmetal products fit to mentioned trademarks and OE numbers in this catalogue.

SOL / LEFT / ЛЕВАЯ

SAĞ / RIGHT / ПРАВАЯ

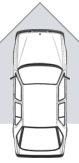

Accent Era 11/2005->

Accent Era (MC) 11/2005->



17HY0515

20HY0515



20HY0515

17HY0516



26HY0515

10KI2000



10KI2000

26HY0516

As Metal Ref.
Код As Metal

Açıklama
Description / Разъяснение

Original Kod
Original Number / Оригинальный Код

| As Metal Ref. Код As Metal | Açıklama Description / Разъяснение | Original Kod Original Number / Оригинальный Код |
|-------------------------------|--|--|
| 10KI2000 | Rotil Ball Joint Шаровая опора | Alt Lower Нижняя |
| 17HY0515 | Rotbaşı Tie Rod End Наконечник рулевой тяги | M14x1,5 Sağ Diş M14x1,5 RHT M14x1,5 Правая Резьба |
| 17HY0516 | Rotbaşı Tie Rod End Наконечник рулевой тяги | M14x1,5 Sağ Diş M14x1,5 RHT M14x1,5 Правая Резьба |
| 20HY0515 | Rotmili Axial Joint Тяга рулевая | M14x1,5 Sağ Diş M14x1,5 RHT M14x1,5 Правая Резьба |
| 26HY0515 | Viraj Rotu Link Stabilizer Тяга стабилизатора | Ön Front Передняя |
| 26HY0516 | Viraj Rotu Link Stabilizer Тяга стабилизатора | Ön Front Передняя |

Asmetal products fit to mentioned trademarks and OE numbers in this catalogue.

SOL / LEFT / ЛЕВАЯ

SAĞ / RIGHT / ПРАВАЯ

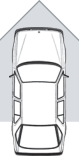
Accent

01/2000->



26HY0505



26HY0510



26HY0511



26HY0505

As Metal Ref.
 Код As Metal

Açıklama
 Description / Разъяснение

Orijinal Kod
 Original Number / Оригинальный Код

| As Metal Ref. Код As Metal | Açıklama Description / Разъяснение | Orijinal Kod Original Number / Оригинальный Код |
|-------------------------------|--|--|
| 26HY0505 | Aski Rotu Thrust Rod Тяга стабилизатора | Arka Rear Задняя 55830-25000 |
| 26HY0510 | Viraj "Z" Rotu Link Stabilizer Тяга стабилизатора | Ön Front Передняя 54830-25010 / 54830-17010 4056A015 / MR 316368 |
| 26HY0511 | Viraj "Z" Rotu Link Stabilizer Тяга стабилизатора | Ön Front Передняя 54830-25020 / 54830-17020 MR 316369 |

SOL / LEFT / ЛЕВАЯ

SAĞ / RIGHT / ПРАВАЯ

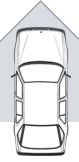
Getz

09/2002->



26HY2001



20HY2005



10HY0500



20HY2005



10HY0500



26HY2000

As Metal Ref.
 Код As Metal

Açıklama
 Description / Разъяснение

Orijinal Kod
 Original Number / Оригинальный Код

| As Metal Ref. Код As Metal | Açıklama Description / Разъяснение | Orijinal Kod Original Number / Оригинальный Код |
|-------------------------------|--|---|
| 10HY0500 | Rotil Ball Joint Шаровая опора | Alt Lower Нижняя 54503 22A00 / 54503 22000 / 54530 2F000 / 54503 25A00 / 54530 25A00 / 54530 25000 / 54530 31600 / 54520 31600 / 54503 31600 / 54503 38A00 / 54530-0U000 / AW311699 / MB241883 / MB303374 / MB303375 |
| 20HY2005 | Rotmili Axial Joint Тяга рулевая | M14x1,5 Sağ Diş M14x1,5 RHT M14x1,5 Правая резьба 57755-1C000 |
| 26HY2000 | Viraj "Z" Rotu Link Stabilizer Тяга стабилизатора | Ön Front Передняя 54840-1C000 |
| 26HY2001 | Viraj "Z" Rotu Link Stabilizer Тяга стабилизатора | Ön Front Передняя 54830-1C000 |

Asmetal products fit to mentioned trademarks and OE numbers in this catalogue.

SOL / LEFT / ЛЕВАЯ

SAĞ / RIGHT / ПРАВАЯ



H-1

06/1997->

Starex

06/1997->



17HY01



20HY10



20HY10



17HY01



17HY1500



17HY1500



17MT0100



17MT0100



26HY1500



10HY1500



10HY1500



26HY1500



10MT0101



10MT0101

As Metal Ref.
Kod As Metal

Açıklama
Description / Разъяснение

Orijinal Kod
Original Number / Оригинальный Код

| As Metal Ref. Kod As Metal | Açıklama Description / Разъяснение | Orijinal Kod Original Number / Оригинальный Код |
|-------------------------------|--|---|
| 10HY1500 | Rotil Ball Joint Шаровая опора | Alt Lower Нижняя |
| 10MT0101 | Rotil Ball Joint Шаровая опора | Üst H-1 İÇİN Upper Верхняя |
| 17HY01 | Rotbaşı Tie Rod End Наконечник рулевой тяги | M14x1,5 Sağ Diş M14x1,5 RHT M14x1,5 Правая Резьба |
| 17HY1500 | Rotbaşı Tie Rod End Наконечник рулевой тяги | M16x1,5 Sağ Diş M16x1,5 RHT M16x1,5 Правая Резьба |
| 17MT0100 | Rotbaşı Tie Rod End Наконечник рулевой тяги | M14x1,5 Sağ Diş M14x1,5 RHT M14x1,5 Правая Резьба |
| 20HY10 | Rotmili Axial Joint Тяга рулевая | M14x1,5 Sağ Diş M14x1,5 RHT M14x1,5 Правая Резьба |
| 26HY1500 | Viraj "Z" Rotu Link Stabilizer Тяга стабилизатора | Ön Front Передняя |
| | | 54530-4AA00 |
| | | 5441 743 A00 / 5441 743 A01 / 5445 743 001 / 5441 747 000 5441 74A A00 / 5441 74A 000 / 5441 74B A00 / MB527350 MB241623/ MB527349 / MR178817 / MR241623 MB59854701 / MB59854801 |
| | | 56820-4A000 / 56820-47300 / 56820-4A600 / 56872 43000 / 56872-43010 / 57705 56820 / MB347599 MB527650 / MB864164 |
| | | 56820 47300 / 56820-47500 / 56820 4A000 / 56820 4A600 / 56872 43000 / 56872 43010 / MB527650 MB864164 |
| | | MB 527 650 / MB 347 599 / MB 864 164 56820-4A000 / 56820-47300 / 56820-4A600 56872 43000 / 56872-43010 / 57705 56820 |
| | | 57730-43010 / 57730-43000 / 57729 4A000 56540 28020 / 57730 24000 / 57730 28500 57730 33100 / 57755 22000 / 56542 4B000 57730 4A000 / 57730 4B000 |
| | | 54830-4A000 |

Asmetal products fit to mentioned trademarks and OE numbers in this catalogue.

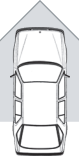
SOL / LEFT / ЛЕВАЯ
SAĞ / RIGHT / ПРАВАЯ

H100

07/1993->



17HY01

20HY10



20HY10

17HY01



17MT0100



17MT0100



17HY1500



17HY1500



10MT0101



10MT0101



10HY10



10HY10

As Metal Ref.
 Код As Metal

Açıklama
 Description / Разъяснение

Orijinal Kod
 Original Number / Оригинальный Код

| As Metal Ref. Код As Metal | Açıklama Description / Разъяснение | Orijinal Kod Original Number / Оригинальный Код |
|-------------------------------|--|---|
| 10MT0101 | Rotil Ball Joint Шаровая опора | Üst Upper Верхняя 5441 743 A00 / 5441 743 A01 / 5445 743 001 / 5441 747 000 5441 74A A00 / 5441 74A 000 / 5441 74B A00 / MB527350 MB241623 / MB527349 / MR178817 / MR241623 MB59854701 / MB59854801 |
| 10HY10 | Rotil Ball Joint Шаровая опора | Alt Lower Нижняя 54510-43150 / 54510-43151 / 54510-43152 / 54540-43150 54540-43151 / 54540-43152 / 54524-43000 / 54524-43001 54524-43002 / MB 527383 / MB 527383-01 MB 527384 / MB 527384-01 / MB 527301 |
| 17HY01 | Rotbaşı Tie Rod End Наконечник рулевой тяги | M14x1,5 Sağ Diş M14x1,5 RHT M14x1,5 Правая Резьба 56820-4A000 / 56820-47300 / 56820-4A600 / 56872 43000 56872-43010 / 57705 56820 / MB347599 MB527650 / MB864164 |
| 17HY1500 | Rotbaşı Tie Rod End Наконечник рулевой тяги | M14x1,5 Sağ Diş M14x1,5 RHT M14x1,5 Правая Резьба 56820 47300 / 56820-47500 / 56820 4A000 56820 4A600 / 56872 43000 / 56872 43010 MB527650 / MB864164 |
| 17MT0100 | Rotbaşı Tie Rod End Наконечник рулевой тяги | M14x1,5 Sağ Diş M14x1,5 RHT M14x1,5 Правая Резьба ->03/2000 ->03/2000 ->03/2000 MB 527 650 / MB 347 599 / MB 864 164 56820-4A000 / 56820-47300 / 56820-4A600 56872 43000 / 56872-43010 / 57705 56820 |
| 20HY10 | Rotmili Axial Joint Тяга рулевая | M14x1,5 Sağ Diş M14x1,5 RHT M14x1,5 Правая Резьба 57730-43010 / 57730-43000 / 57729 4A000 56540 28020 / 57730 24000 / 57730 28500 57730 33100 / 57755 22000 / 56542 4B000 57730 4A000 / 57730 4B000 |

Asmetal products fit to mentioned trademarks and OE numbers in this catalogue.

SOL / LEFT / ЛЕВАЯ

SAĞ / RIGHT / ПРАВАЯ

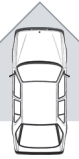

i20

08/2008->



10HY0500



10HY0500

As Metal Ref.
Код As Metal

Açıklama
Description / Разъяснение

Orijinal Kod
Original Number / Оригинальный Код

10HY0500

Rotil
Ball Joint
Шаровая опора

Alt
Lower
Нижняя

54503 22A00 / 54503 22000 / 54530 2F000 / 54503 25A00 / 54530 25A00
/ 54530 25000 / 54530 31600 54520 31600 / 54503 31600 54503 38A00 /
54530-0U000 / AW311699 / MB241883 / MB303374 / MB303375

SOL / LEFT / ЛЕВАЯ

SAĞ / RIGHT / ПРАВАЯ

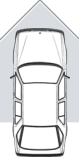

i30

10/2007->

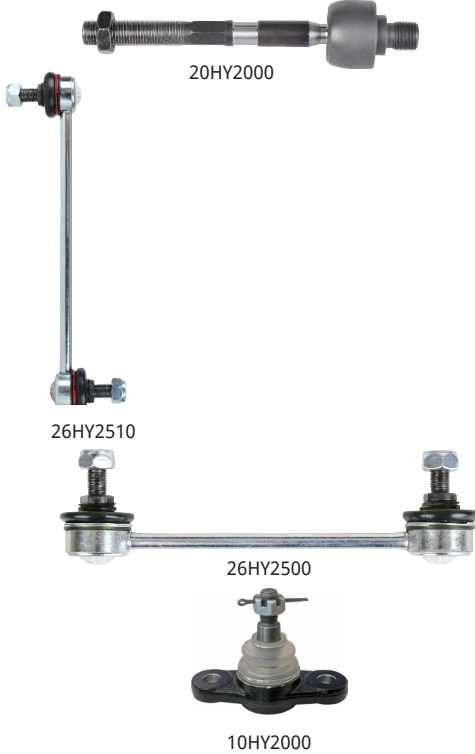

As Metal Ref.
Код As Metal

Açıklama
Description / Разъяснение

Orijinal Kod
Original Number / Оригинальный Код

10HY2000

Rotil
Ball Joint
Шаровая опора

Alt, Ön
Lower, Front
Нижняя, Передняя

51760-2H000
51760-2G000
51760-0Q000

20HY2000

Rotmili
Axial Joint
Тяга рулевая

M14x1,5 Sağ Diş
M14x1,5 RHT
M14x1,5 Правая Резьба

56540-2H000

26HY2500

Viraj Rotu
Link Stabilizer
Тяга стабилизатора

Arka
Rear
Задняя

55530-2H000
55530-1H000

26HY2510

Viraj "Z" Rotu
Link Stabilizer
Тяга стабилизатора

Ön
Front
Передняя

54830-2H100 / 54830-2H000
54830-2H001

Asmetal products fit to mentioned trademarks and OE numbers in this catalogue.

SOL / LEFT / ЛЕВАЯ

SAĞ / RIGHT / ПРАВАЯ

Elantra 06/2000->





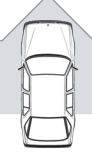

| As Metal Ref. Код As Metal | Açıklama Description / Разъяснение | Orijinal Kod Original Number / Оригинальный Код |
|-------------------------------|--|--|
| 10HY0500 | Rotil Ball Joint Шаровая опора | Alt Lower Нижняя 54503 22A00 / 54503 22000 / 54530 2F000 / 54503 25A00 / 54530 25A00 54530 25000 / 54530 31600 / 54520 31600 / 54503 31600 / 54503 38A00 54530-0U000 / AW311699 / MB241883 / MB303374 / MB303375 |
| 17HY0500 | Rotbaşı Tie Rod End Наконечник рулевой тяги | M14x1,5 Sağ Diş M14x1,5 RHT M14x1,5 Правая Резьба 56820-22000 / 56820-25000 56820-28500 / 56820-37000 56820-37010 |
| 26HY0605 | Viraj Rotu Link Stabilizer Тяга стабилизатора | Arka Rear Задняя ->07/2006 ->07/2006 ->07/2006 55530-29500 / 55530-29000 55530-17000 / 55530-17010 55530-29300 |

SOL / LEFT / ЛЕВАЯ

SAĞ / RIGHT / ПРАВАЯ

Elantra 02/2006->





| As Metal Ref. Код As Metal | Açıklama Description / Разъяснение | Orijinal Kod Original Number / Оригинальный Код |
|-------------------------------|--|---|
| 10HY2000 | Rotil Ball Joint Шаровая опора | Alt, Ön Lower, Front Нижняя, Передняя 51760-2H000 51760-2G000 51760-0Q000 |
| 26HY2500 | Viraj Rotu Link Stabilizer Тяга стабилизатора | Arka Rear Задняя 55530-2H000 55530-1H000 |
| 26HY2510 | Viraj "Z" Rotu Link Stabilizer Тяга стабилизатора | Ön Front Передняя 54830-2H100 / 54830-2H000 54830-2H001 |

Asmetal products fit to mentioned trademarks and OE numbers in this catalogue.

SOL / LEFT / ЛЕВАЯ

SAĞ / RIGHT / ПРАВАЯ

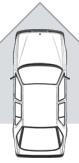

Lantra I 10/1990->11/1995



17HY0500



17HY0500



26HY0100



10HY0600



10HY0600



26HY0100

HYUNDAI

| As Metal Ref. Код As Metal | Açıklama Description / Разъяснение | | Orijinal Kod Original Number / Оригинальный Код |
|-------------------------------|--|--|---|
| 10HY0600 | Rotil Ball Joint Шаровая опора | Alt Lower Нижняя | 54530-28A00 54530-28000 |
| 17HY0500 | Rotbaşı Tie Rod End Наконечник рулевой тяги | M14x1,5 Sağ Diş M14x1,5 RHT M14x1,5 Правая Резьба | 56820-22000 / 56820-25000 56820-28500 / 56820-37000 56820-37010 |
| 26HY0100 | Viraj Rotu Link Stabilizer Тяга стабилизатора | Ön Front Передняя | 54830-28000 / 54830-37020 48820-33010 / 48820-02010 |

Asmetal products fit to mentioned trademarks and OE numbers in this catalogue.

SOL / LEFT / ЛЕВАЯ

SAĞ / RIGHT / ПРАВАЯ

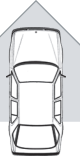

Lantra II 11/1995->09/2000



17HY0500



17HY0500



26HY0600



26HY0600



26HY0605



10HY0500



10HY0500



26HY0605

HYUNDAI

| As Metal Ref. Код As Metal | Açıklama Description / Разъяснение | Orijinal Kod Original Number / Оригинальный Код |
|-------------------------------|--|---|
| 10HY0500 | Rotil Ball Joint Шаровая опора | Alt Lower Нижняя 54503 22A00 / 54503 22000 / 54530 2F000 / 54503 25A00 / 54530 25A00 / 54530 25000 / 54530 31600 / 54520 31600 / 54503 31600 54503 38A00 / 54530-0U000 / AW311699 // MB241883 / MB303374 MB303375 |
| 17HY0500 | Rotbaşı Tie Rod End Наконечник рулевой тяги | M14x1,5 Sağ Diş M14x1,5 RHT M14x1,5 Правая Резьба 56820-22000 / 56820-25000 56820-28500 / 56820-37000 56820-37010 |
| 26HY0600 | Viraj Rotu Link Stabilizer Тяга стабилизатора | Ön Front Передняя 54830-29000 54830-29500 |
| 26HY0605 | Viraj Rotu Link Stabilizer Тяга стабилизатора | Arka Rear Задняя 55530-29500 / 55530-29000 55530-17000 / 55530-17010 55530-29300 |

Asmetal products fit to mentioned trademarks and OE numbers in this catalogue.

↑

↑

SOL / LEFT / ЛЕВАЯ **SAĞ / RIGHT / ПРАВАЯ**

Pony 1990->1994

17HY1000
20HY10
10HY0600

Excel 1990->1994

20HY10
10HY0600

S.Coupe 02/1990->05/1996

20HY10
10HY0600
17HY1000

| As Metal Ref. Код As Metal | Açıklama Description / Разъяснение | Orijinal Kod Original Number / Оригинальный Код |
|-------------------------------|--|--|
| 10HY0600 | Rotil Ball Joint Шаровая опора | Alt Excel Hariç Lower Except Excel Нижняя Кроме Excel |
| 17HY1000 | Rotbaşı Tie Rod End Наконечник рулевой тяги | M14x1,5 Sağ Diş M14x1,5 RHT M14x1,5 Правая Резьба |
| 20HY10 | Rotmili Axial Joint Тяга рулевая | M14x1,5 Sağ Diş M14x1,5 RHT M14x1,5 Правая Резьба |
| | | 54530-28A00 54530-28000 |
| | | 56820-21110 OK201 32280A |
| | | 57730-43010 / 57730-43000 / 57729 4A000 56540 28020 / 57730 24000 / 57730 28500 57730 33100 / 57755 22000 / 56542 4B000 57730 4A000 / 57730 4B000 |

↑

↑

SOL / LEFT / ЛЕВАЯ **SAĞ / RIGHT / ПРАВАЯ**

Sonata I 09/1988->10/1993

17HY0500
20HY10
10HY0500
10HY3000

Sonata II 05/1993->06/1998

20HY10
20HY3005
10HY3000
10HY0500

Trajat 03/2000->

17HY0500
20HY10
20HY3005
10HY3000
10HY0500

| As Metal Ref. Код As Metal | Açıklama Description / Разъяснение | Orijinal Kod Original Number / Оригинальный Код |
|-------------------------------|--|--|
| 10HY3000 | Rotil Ball Joint Шаровая опора | Alt, Ön Lower, Front Нижняя, Передняя |
| 10HY0500 | Rotil Ball Joint Шаровая опора | Trajat için Except Trajet Кроме Excel |
| 17HY0500 | Rotbaşı Tie Rod End Наконечник рулевой тяги | M14x1,5 Sağ Diş M14x1,5 RHT M14x1,5 Правая Резьба |
| 20HY10 | Rotmili Axial Joint Тяга рулевая | M14x1,5 Sağ Diş (Sonata II için) M14x1,5 RHT (Only Sonata II) M14x1,5 Правая Резьба (На Sonata II) |
| 20HY3005 | Rotmili Axial Joint Тяга рулевая | M14x1,5 Sağ Diş M14x1,5 RHT M14x1,5 Правая резьба |
| | | 54503-3BA00 / 54530-2B000 54530-3B000 / 54530-3BA00 |
| | | 54503 22A00 / 54503 22000 / 54530 2F000 / 54503 25A00 / 54530 25A00 54530 25000 / 54530 31600 / 54520 31600 / 54503 31600 54503 38A00 / 54530-0U000 / AW311699 MB241883 / MB303374 / MB303375 |
| | | 56820-22000 / 56820-25000 56820-28500 / 56820-37000 56820-37010 |
| | | 57730-43010 / 57730-43000 / 57729 4A000 56540 28020 / 57730 24000 / 57730 28500 57730 33100 / 57755 22000 / 56542 4B000 57730 4A000 / 57730 4B000 |
| | | 57716-34000 / 57785-26200 57724-3A000 / 57755-17000 |

Asmetal products fit to mentioned trademarks and OE numbers in this catalogue.

SOL / LEFT / ЛЕВАЯ



SAĞ / RIGHT / ПРАВАЯ

Sonata III 05/1993->06/1998



20HY3005



20HY3005

As Metal Ref.
Код As Metal

Açıklama
Description / Разъяснение

Orijinal Kod
Original Number / Оригинальный Код

20HY3005

Rotmili
Axial Joint
Тяга рулевая

M14x1.5 Sağ Diş
M14x1,5 RHT
M14x1,5 Правая резьба

57716-34000 / 57785-26200
57724-3A000 / 57755-17000

SOL / LEFT / ЛЕВАЯ



SAĞ / RIGHT / ПРАВАЯ

Sonata IV 03/1998->10/2001

XG 12/1998->



10HY0500



10HY0500

As Metal Ref.
Код As Metal

Açıklama
Description / Разъяснение

Orijinal Kod
Original Number / Оригинальный Код

10HY0500

Rotil
Ball Joint
Шаровая опора

Alt
Lower
Нижняя

54503 22A00 / 54503 22000 / 54530 2F000 / 54503 25A00 / 54530 25A00 / 54530 25000 / 54530 31600 / 54520 31600 / 54503 31600 54503 38A00 / 54530-0U000 / AW311699 / MB241883 / MB303374 MB303375

SOL / LEFT / ЛЕВАЯ

SAĞ / RIGHT / ПРАВАЯ

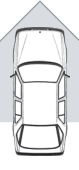

Santa Fe I 10/2005->03/2006

Santa Fe II 03/2006->



17HY3000

20HY3000

20HY3000

17HY3001



20HY3005



20HY3005



26HY3000

26HY3010



26HY3005



26HY3005



26HY3011

26HY3000



10HY3000



10HY3000

As Metal Ref.
Код As Metal

Açıklama
Description / Разъяснение

Orijinal Kod
Original Number / Оригинальный Код

| As Metal Ref. Код As Metal | Açıklama Description / Разъяснение | Orijinal Kod Original Number / Оригинальный Код |
|-------------------------------|--|---|
| 10HY3000 | Rotil Ball Joint Шаровая опора | Alt, Ön Lower, Front Нижняя, Передняя (02/2001->) |
| 17HY3000 | Rotbaşı Tie Rod End Наконечник рулевой тяги | M16x1.5 Sağ Diş M16x1,5 RHT M16x1,5 Правая резьба |
| 17HY3001 | Rotbaşı Tie Rod End Наконечник рулевой тяги | M16x1.5 Sağ Diş M16x1,5 RHT M16x1,5 Правая резьба |
| 20HY3000 | Rotmili Axial Joint Тяга рулевая | M14x1.5 Sağ Diş (Santa Fe II için) M14x1,5 RHT (Only Santa Fe II) M14x1,5 Правая резьба (Na Santa Fe II) |
| 20HY3005 | Rotmili Axial Joint Тяга рулевая | M14x1.5 Sağ Diş Sante FE I için M14x1,5 RHT For Sante FE I M14x1,5 Правая резьба Для Sante FE I |
| 26HY3000 | Viraj "Z" Rotu Link Stabilizer Тяга стабилизатора | - |
| 26HY3005 | Viraj "Z" Rotu Link Stabilizer Тяга стабилизатора | Arka Rear Задняя |
| 26HY3010 | Viraj "Z" Rotu Link Stabilizer Тяга стабилизатора | Ön Front Передняя SANTA FE I için For Sante FE I Для Sante FE I |
| 26HY3011 | Viraj "Z" Rotu Link Stabilizer Тяга стабилизатора | Ön Front Передняя SANTA FE I için For Sante FE I Для Sante FE I |

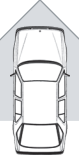
SOL / LEFT / ЛЕВАЯ
SAĞ / RIGHT / ПРАВАЯ

Matrix
06/2001->

17HY0500



20HY3005



20HY3005



17HY0500



26HY0510



26HY0605



10HY0500



10HY0500



26HY0605



26HY0511

HYUNDAI
As Metal Ref.
 Код As Metal

Açıklama
 Description / Разъяснение

Orijinal Kod
 Original Number / Оригинальный Код

| As Metal Ref. Код As Metal | Açıklama Description / Разъяснение | Orijinal Kod Original Number / Оригинальный Код |
|-------------------------------|--|--|
| 10HY0500 | Rotil Ball Joint Шаровая опора | Alt Lower Нижняя |
| 17HY0500 | Rotbaşı Tie Rod End Наконечник рулевой тяги | M14x1,5 Sağ Diş M14x1,5 RHT M14x1,5 Правая Резьба |
| 20HY3005 | Rotmili Axial Joint Тяга рулевая | M14x1,5 Sağ Diş M14x1,5 RHT M14x1,5 Правая Резьба |
| 26HY0605 | Viraj Rotu Link Stabilizer Тяга стабилизатора | Arka -->08/2010 Rear -->08/2010 Задняя -->08/2010 |
| 26HY0510 | Viraj "Z" Rotu Link Stabilizer Тяга стабилизатора | Ön Front Передняя |
| 26HY0511 | Viraj "Z" Rotu Link Stabilizer Тяга стабилизатора | Ön Front Передняя |

Asmetal products fit to mentioned trademarks and OE numbers in this catalogue.